

Price List

EUROPE

1st Half / 2024



BRDR. KRÜGER

DANISH CRAFT AND DESIGN

1886

Index

Tables	Bølling Collection , Hans Bølling	4-17
	HB Coffee Table , Hans Bølling	18
	Jari Table Collection , OEO Studio	19-28
	Arv Collection , David Thulstrup	29-32
	TRIIIIO Collection , Hans Bølling	33-36
Seating	HB Lounge Chair , Hans Bølling	38-40
	Arv Dining Chair , David Thulstrup	41-46
	Arv Lounge Chair , David Thulstrup	47-48
	Arkade Chair , Nanna Ditzel	49-53
	F-Chair , Rasmus B. Fex	54-59
	Pauline Bar Stool , OEO Studio	60-72
	Jari Dining Chair , OEO Studio	73-74
	Ferdinand Lounge Chair , OEO Studio	75-76
	Karm Sofa , Studio David Thulstrup	77-80
Lighting	Lune Collection , Sverre Uhnger	82-84
Complements	Mokuba Rocking Horse , O&M Design	86
	Orbis Table , O&M Design	87
	Samples	88
General Information	Sustainability	90
	Material Information	91-98
	How to Order	100
	General Terms & Conditions	101-104
	Contact Information	105

Tables



Bølling Tray Table

by Hans Bølling





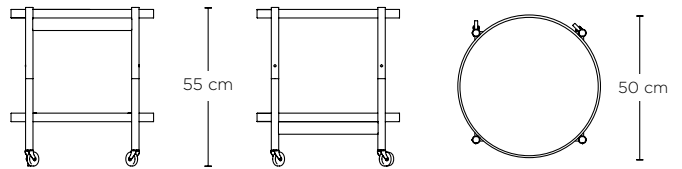

Bølling Tray Table
Hans Bølling

 BRDR. KRÜGER



Bølling Tray Table - Model 50
Hans Bølling



		EURO ex. VAT	#Reference
	Beech, Untreated	611	BBO1-BUN
	Beech, Oiled	703	BBO1-BOL
	Oak, Untreated	722	BBO1-OUN
	Oak, Oiled	813	BBO1-OOL
	Oak, Black Lacquer	905	BBO1-OBA
	Fumed Oak, Oiled	905	BBO1-OFU
	Walnut, Oiled	1.089	BBO1-WOL

Tray Colour	# Reference
	BASE (Black / White) BA
	STONE (Grey / Dark Grey) ST
	EARTH (Beige / Brown) EA
	LEAF (Green / Dark Green) LE
	WATER (Blue / Dark Blue) WA
	SUNNY (Cream / Yellow) SU
	CLAY (Cognac / Black) CL
	RED (Red / Black) RE







Dimensions	
Diameter	Ø50 cm
Height	55 cm
Tray Height	3 cm
Box	79 x 13 x 58 cm
Weight	4,5 kg

Notes:

- Shipped flat packed.
- Ready to assemble, no tools needed.
- Top and bottom trays come in the same colour combination as standard.
- Handling cost of choosing two different colour combinations is 30 EURO.

Bølling Serving Tray - Model 50
Hans Bølling









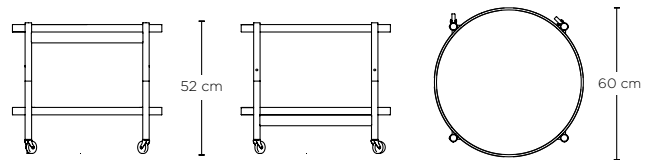

		EURO ex. VAT	#Reference
	Beech, Untreated	204	BBB1-BUN
	Beech, Oiled	234	BBB1-BOL
	Oak, Untreated	241	BBB1-OUN
	Oak, Oiled	271	BBB1-OOL
	Oak, Black Lacquer	302	BBB1-OBA
	Fumed Oak, Oiled	302	BBB1-OFU
	Walnut, Oiled	363	BBB1-WOL

Tray Colour	# Reference
	BASE (Black / White) BA
	STONE (Grey / Dark Grey) ST
	EARTH (Beige / Brown) EA
	LEAF (Green / Dark Green) LE
	WATER (Blue / Dark Blue) WA
	SUNNY (Cream / Yellow) SU
	CLAY (Cognac / Black) CL
	RED (Red / Black) RE

Dimensions	
Diameter	Ø50 cm
Height	3 cm
Box	52 x 52 x 4 cm
Weight	2 kg

Bølling Tray Table - Model 60
Hans Bølling



		EURO ex. VAT	#Reference
	Beech, Untreated	734	BBO3-BUN
	Beech, Oiled	826	BBO3-BOL
	Oak, Untreated	869	BBO3-OUN
	Oak, Oiled	960	BBO3-OOL
	Oak, Black Lacquer	1.113	BBO3-OBA
	Fumed Oak, Oiled	1.113	BBO3-OFU
	Walnut, Oiled	1.307	BBO3-WOL







Tray Colour	# Reference
	BASE (Black / White) BA
	STONE (Grey / Dark Grey) ST
	EARTH (Beige / Brown) EA
	LEAF (Green / Dark Green) LE
	WATER (Blue / Dark Blue) WA
	SUNNY (Cream / Yellow) SU
	CLAY (Cognac / Black) CL
	RED (Red / Black) RE









Dimensions	
Diameter	Ø60 cm
Height	52 cm
Tray Height	2,5 cm
Box	90 x 12 x 60 cm
Weight	5,5 kg

Notes:

- Shipped flat packed.
- Ready to assemble, no tools needed.
- Top and bottom trays come in the same colour combination as standard.
- Handling cost of choosing two different colour combinations is 30 EURO.



		EURO ex. VAT	#Reference
	Beech, Untreated	245	BBB2-BUN
	Beech, Oiled	275	BBB2-BOL
	Oak, Untreated	290	BBB2-OUN
	Oak, Oiled	320	BBB2-OOL
	Oak, Black Lacquer	371	BBB2-OBA
	Fumed Oak, Oiled	371	BBB2-OFU
	Walnut, Oiled	436	BBB2-WOL

Tray Colour	# Reference	Dimensions
	BASE (Black / White) BA	Diameter Ø60 cm
	STONE (Grey / Dark Grey) ST	Height 2,5 cm
	EARTH (Beige / Brown) EA	Box 62 x 62 x 4 cm
	LEAF (Green / Dark Green) LE	Weight 2,5 kg
	WATER (Blue / Dark Blue) WA	
	SUNNY (Cream / Yellow) SU	
	CLAY (Cognac / Black) CL	
	RED (Red / Black) RE	



Bølling Veneer Tray Table

by Hans Bølling





Bølling Veneer Tray Table
Hans Bølling

 BRDR. KRÜGER

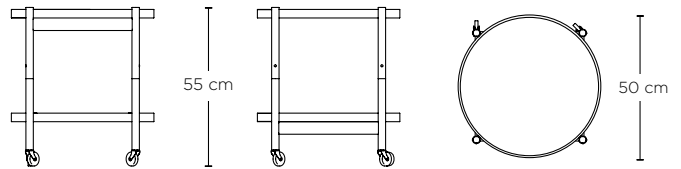

Bølling Tray Table - Veneer Model 50
Hans Bølling



		EURO ex. VAT	#Reference
	Beech, Oiled	795	BBO1-BOL-VV
	Oak, Oiled	905	BBO1-OOL-VV
	Oak, Black Lacquer	997	BBO1-OBA-VV
	Fumed Oak, Oiled	997	BBO1-OFU-VV
	Walnut, Oiled	1.181	BBO1-WOL-VV

Dimensions





Diameter	Ø50 cm
Height	55 cm
Tray Height	3 cm
Box	79 x 13 x 58 cm
Weight	4,5 kg

Notes:

- Shipped flat packed.
- Ready to assemble, no tools needed.
- Both sides of the trays are made of veneer.
- Handling cost of choosing different combinations is 30 EURO.

Bølling Serving Tray - Veneer Model 50
Hans Bølling







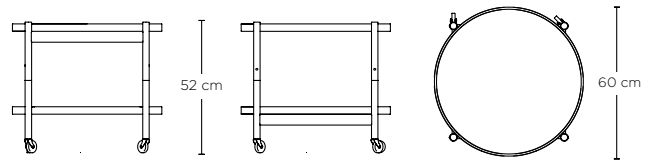

		EURO ex. VAT	#Reference
	Beech, Oiled	265	BBB1-BOL-VV
	Oak, Oiled	302	BBB1-OOL-VV
	Oak, Black Lacquer	332	BBB1-OBA-VV
	Fumed Oak, Oiled	332	BBB1-OFU-VV
	Walnut, Oiled	394	BBB1-WOL-VV

Dimensions

Diameter	Ø50 cm
Height	3 cm
Box	52 x 52 x 4 cm
Weight	2 kg

Bølling Tray Table - Veneer Model 60
Hans Bølling



		EURO ex. VAT	#Reference
	Beech, Oiled	948	BBO3-BOL-VV
	Oak, Oiled	1.083	BBO3-OOL-VV
	Oak, Black Lacquer	1.236	BBO3-OBA-VV
	Fumed Oak, Oiled	1.236	BBO3-OFU-VV
	Walnut, Oiled	1.429	BBO3-WOL-VV

Dimensions





Diameter	Ø60 cm
Height	52 cm
Tray Height	2,5 cm
Box	90 x 12 x 60 cm
Weight	5,5 kg

Notes:

- Shipped flat packed.
- Ready to assemble, no tools needed.
- Both sides of the trays are made of veneer.
- Handling cost of choosing different combinations is 30 EURO.

Bølling Serving Tray - Veneer Model 60
Hans Bølling



		EURO ex. VAT	#Reference
	Beech, Oiled	316	BBB2-BOL-VV
	Oak, Oiled	361	BBB2-OOL-VV
	Oak, Black Lacquer	412	BBB2-OBA-VV
	Fumed Oak, Oiled	412	BBB2-OFU-VV
	Walnut, Oiled	476	BBB2-WOL-VV

Dimensions

Diameter	Ø60 cm
Height	2,5 cm
Box	62 x 62 x 4 cm
Weight	2,5 kg



	EURO ex. VAT	#Reference
Wheel Set for Bølling Tray Table	45	BBhjul

Note:

Set with 4 wheels.





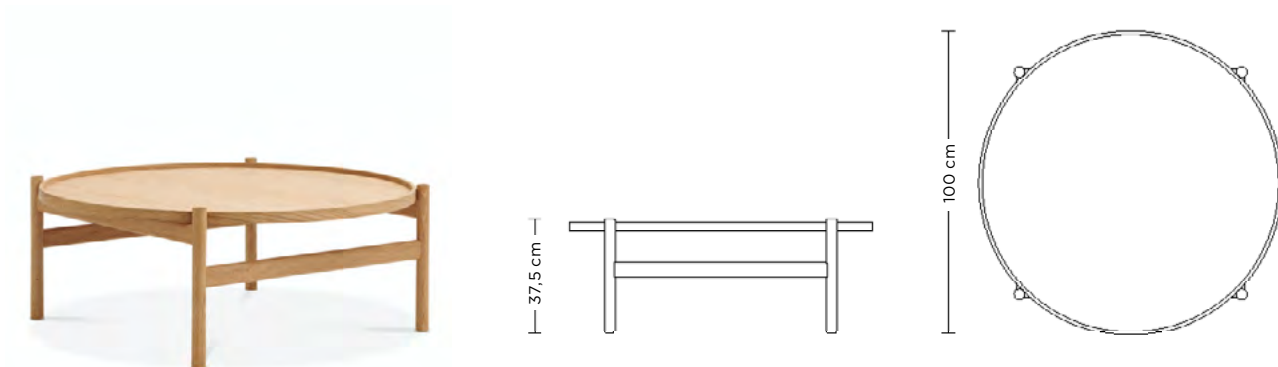

HB Coffee Table

by Hans Bølling

HB Coffee Table
Hans Bølling



		EURO ex. VAT	#Reference
	Oak, Oiled	1.591	BOO9-OOL
	Fumed Oak, Oiled	1.774	BOO9-OFU
	Maple, White Oiled	1.591	BOO9-MWO
	Cherry, Oiled	1.774	BOO9-COL

Dimensions

Diameter	Ø100 cm
Height	37,5 cm
Tray Height	3 cm
Box	102 x 102 x 38 cm
Weight	12 kg



Jari Table Collection

by OEO Studio

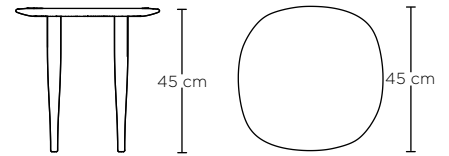

	EURO ex. VAT	#Reference
 Oak, Oiled	1.204	JAJ1-OOL
 Fumed Oak, Oiled	1.296	JAJ1-OFU

Notes:

- Shipped flat packed.
- Ready to assemble, no tools needed.
- Fumed colors will vary accross the table.
Read more under material information.

Dimensions

Diameter	Ø45 cm
Height	45 cm
Solid Wood Table Top Thickness	2,5 cm
Box (top)	47 x 47 x 4 cm
Box (legs)	47 x 16 x 11 cm
Weight	5 kg

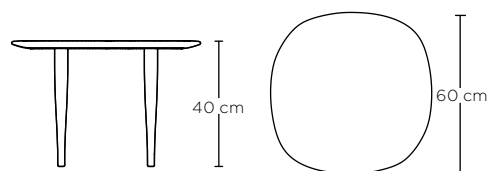

	EURO ex. VAT	#Reference
 Oak, Oiled	1.362	JAJ2-OOL
 Fumed Oak, Oiled	1.454	JAJ2-OFU

Notes:

- Shipped flat packed.
- Ready to assemble, no tools needed.
- Fumed colors will vary accross the table.
Read more under material information.

Dimensions

Diameter	Ø60 cm
Height	40 cm
Solid Wood Table Top Thickness	2,5 cm
Box (top)	63 x 63 x 4 cm
Box (legs)	47 x 16 x 11 cm
Weight	8 kg

Jari Coffee Table Round - Model C85

OEO Studio

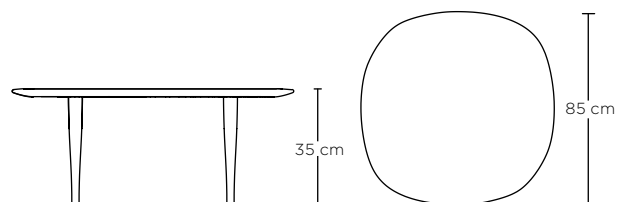

	EURO ex. VAT	#Reference
 Oak, Oiled	1.587	JAJ3-OOL
 Fumed Oak, Oiled	1.678	JAJ3-OFU

Notes:

- Shipped flat packed.
- Ready to assemble, no tools needed.
- Fumed colors will vary across the table.
Read more under material information.

Dimensions

Diameter	Ø85 cm
Height	35 cm
Solid Wood Table Top Thickness	2,5 cm
Box (top)	93 x 93 x 4 cm
Box (legs)	37 x 16 x 11 cm
Weight	15 kg

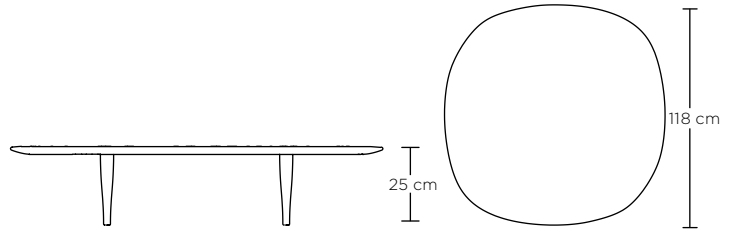

	EURO ex. VAT	#Reference
 Oak, Oiled	2.541	JAJ4-OOL
 Fumed Oak, Oiled	2.756	JAJ4-OFU

Notes:

- Shipped flat packed.
- Ready to assemble, no tools needed.
- Fumed colors will vary accross the table.
 Read more under material information.

Dimensions

Diameter	Ø118 cm
Height	25 cm
Solid Wood Table Top Thickness	2,5 cm
Box (top)	125 x 125 x 4 cm
Box (legs)	37 x 16 x 11 cm

Jari Ellipse Coffee Table - Model E130
 OEO Studio

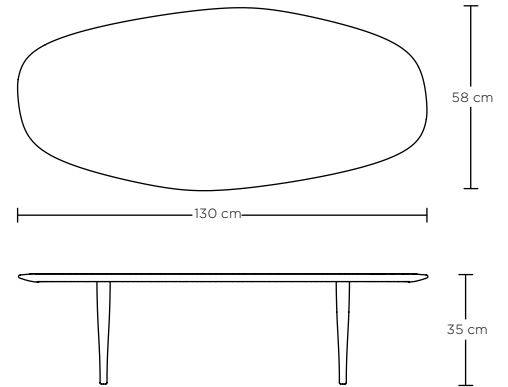

	EURO ex. VAT	#Reference
 Oak, Oiled	2.379	JAJ5-OOL
 Fumed Oak, Oiled	2.593	JAJ5-OFU

Notes:

- Shipped flat packed.
- Ready to assemble, no tools needed.
- Fumed colors will vary accross the table.
 Read more under material information.

Dimensions

Length	130 cm
Width	58 cm
Height	35 cm
Solid Oak Table Top Thickness	2,5 cm
Box (top)	133 x 61 x 4 cm
Box (legs)	37 x 16 x 11 cm

Jari Ellipse Coffee Table - Model E180
OEO Studio

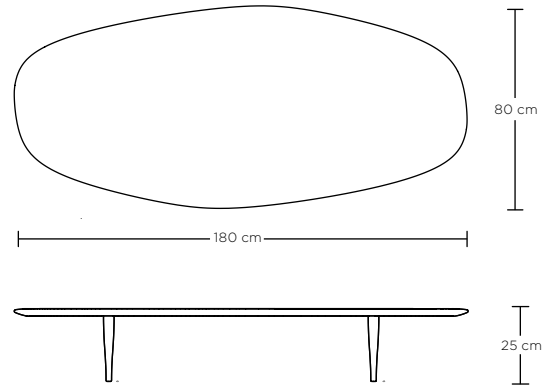

	EURO ex. VAT	#Reference
 Oak, Oiled	3.078	JAJ6-OOL
 Fumed Oak, Oiled	3.537	JAJ6-OFU

Notes:

- Shipped flat packed.
- Ready to assemble, no tools needed.
- Fumed colors will vary across the table.
Read more under material information.

Dimensions

Length	180 cm
Width	80 cm
Height	25 cm
Solid Oak Table Top Thickness	2,5 cm
Box (top)	183 x 83 x 4 cm
Box (legs)	37 x 16 x 11 cm



Jari Dining Table

by OEO Studio

Jari Dining Table - Model C120
OEO Studio

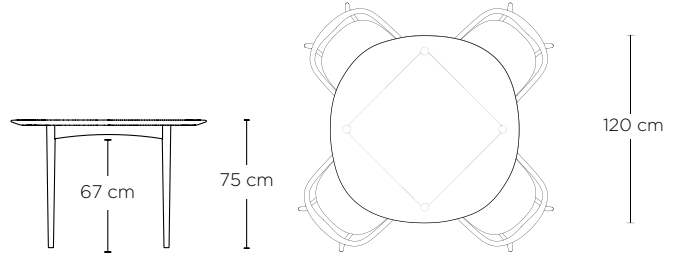

	EURO ex. VAT	#Reference
 Oak, Oiled	3.743	JA06-OOL
 Fumed Oak, Oiled	4.202	JA06-OFU
 Ash, Black Lacquer	4.202	JA06-ABA

Notes:



- Available only for selected dealers.
- Approved for hotel / restaurant (EN 15372: 2016, Test level 2 General)
- Fumed colors will vary across the table. Read more under material information.
- Shipped knock down.

Dimensions

Diameter	Ø120 cm
Height	75 cm
Solid Wood Table Top Thickness	3 cm
Box	124 x 124 x 14 cm
Weight	60 kg

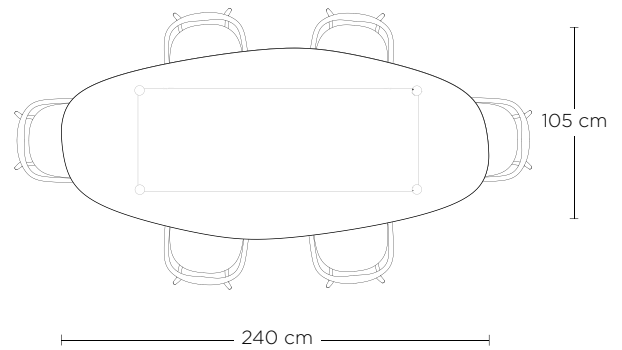
Jari Ellipse Dining Table - Model E240
 OEO Studio



	EURO ex. VAT	#Reference
 Oak, Oiled	5.616	JAT3-OOL
 Fumed Oak, Oiled	6.228	JAT3-OFU
 Ash, Black Lacquer	6.228	JAT3-ABA

Notes:

- Available only for selected dealers.
- Approved for hotel / restaurant (EN 15372: 2016, Test level 2 General)
- Fumed colors will vary accross the table. Read more under material information.
- Shipped knock down.

Dimensions

Length	240 cm
Width	105 cm
Height	75 cm
Solid Wood Table Top Thickness	3 cm
Box	245 x 110 x 14 cm
Weight	80 kg



Arv Dining Table

by David Thulstrup

ARV Dining Table - Ø 120 cm
David Thulstrup

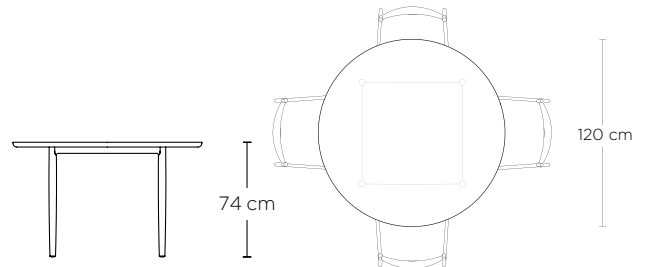

	EURO ex. VAT	#Reference
 Oak, White Oiled	4.624	AVO6-OWO
 Oak, Oiled	4.624	AVO6-OOL
 Fumed Oak, Oiled	5.083	AVO6-OFU
<hr/>		
120 Wooden Expo Box	230	BOX120

Notes:

- Available only for selected dealers.
- Approved for hotel / restaurant (EN 15372: 2016, Test level 2 General)
- Fumed colors will vary accross the table. Read more under material information.
- Shipped assembled.
- When making purchases outside Denmark, using the expo box is required unless the client prefers to pick up the items themselves.
- Contact Brdr. Krüger for custom sizes.

Dimensions

Diameter	Ø120 cm
Height	74 cm
Solid Oak Table Top Thickness	2,6 cm
Export Box	123 x 123 x 93 cm
Weight (including box)	75 kg

ARV Dining Table - 90x180 cm
David Thulstrup

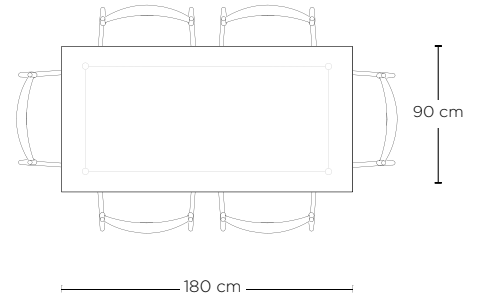

	EURO ex. VAT	#Reference
 Oak, White Oiled	5.946	AVT1-OWO
 Oak, Oiled	5.946	AVT1-OOL
 Fumed Oak, Oiled	6.558	AVT1-OFU
<hr/>		
180 Wooden Expo Box	267	BOX180

Notes:

- Available only for selected dealers.
- Approved for hotel / restaurant (EN 15372: 2016, Test level 2 General)
- Fumed colors will vary accross the table. Read more under material information.
- Shipped assembled.
- When making purchases outside Denmark, using the expo box is required unless the client prefers to pick up the items themselves.
- Contact Brdr. Krüger for custom sizes.

Dimensions

Length	180 cm
Width	90 cm
Height	74 cm
Solid Oak Table Top Thickness	2,6 cm
Export Box	183 x 93 x 93 cm
Weight (including box)	100 kg

ARV Dining Table - 90x240 cm
David Thulstrup

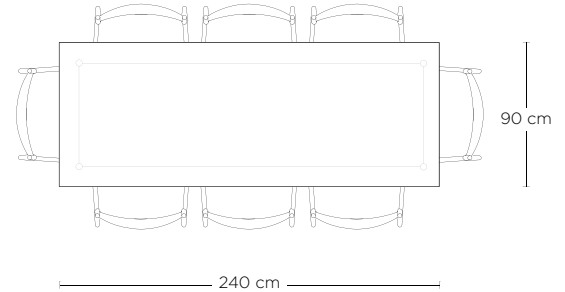

	EURO ex. VAT	#Reference
 Oak, White Oiled	6.718	AVT2-OWO
 Oak, Oiled	6.718	AVT2-OOL
 Fumed Oak, Oiled	7.330	AVT2-OFU
<hr/>		
240 Wooden Expo Box	375	BOX240

Notes:

- Available only for selected dealers.
- Approved for hotel / restaurant (EN 15372: 2016, Test level 2 General)
- Fumed colors will vary accross the table. Read more under material information.
- Shipped assembled.
- When making purchases outside Denmark, using the expo box is required unless the client prefers to pick up the items themselves.
- Contact Brdr. Krüger for custom sizes.

Dimensions

Length	240 cm
Width	90 cm
Height	74 cm
Solid Oak Table Top Thickness	2,6 cm
Export Box	243 x 93 x 93 cm
Weight (including box)	125 kg







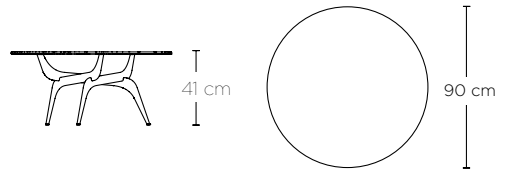

TRIIIIO Table Collection

by Hans Bølling

TRIII Coffee Table
Hans Bølling



	EURO ex. VAT	#Reference
 Oak, Untreated	1.462	TRO5-OUN
 Oak, Oiled	1.554	TRO5-OOL
 Fumed Oak, Oiled	1.768	TRO5-OFU
 Walnut, Oiled	2.331	TRO5-WOL

Glass Colour	# Reference
 Clear	CG
 Bronze	BG





Dimension	
Diameter	Ø90 cm
Height	41 cm
Hardened Glass Thickness	1 cm
Box (glass)	93,5 x 93,5 x 6 cm
Box (legs)	81 x 26 x 7 cm
Total Weight	18 kg

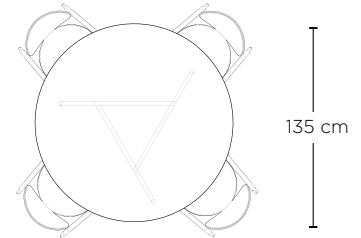
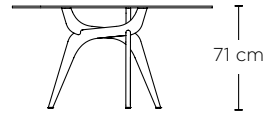

Notes:

- Shipped flat packed.
- Ready to assemble, no tools needed.
- Fumed colors will vary across the table.
Read more under material information.

TRIIIIO Dining Table - Ø135 cm
Hans Bølling



	EURO ex. VAT	#Reference
 Oak, Untreated	3.323	TRO7-OUN
 Oak, Oiled	3.507	TRO7-OOL
 Fumed Oak, Oiled	3.813	TRO7-OFU
 Walnut, Oiled	5.260	TRO7-WOL

Glass Colour	# Reference
 Clear	CG
 Bronze	BG

Dimensions	
Diameter	Ø135 cm
Height	71 cm
Hardened Glass Thickness	1 cm
Box (glass)	136 x 136 x 3,5 cm
Box (legs)	86 x 86 x 80 cm
Total Weight	55,5 kg

Notes:

- Shipped flat packed.
- Ready to assemble, no tools needed.
- Fumed colors will vary accross the table.
Read more under material information.

TRIII Dining Table - Solid Table Top Ø120 cm
 Hans Bølling

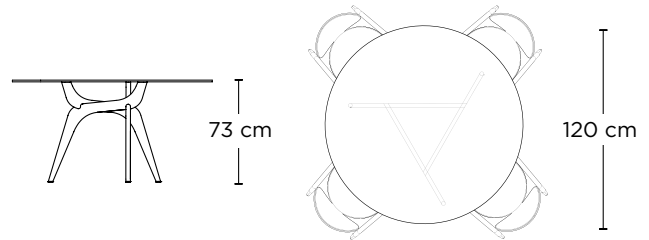

	EURO ex. VAT	#Reference
 Oak, Oiled	3.889	TRO6-OOL-OT
 Fumed Oak, Oiled	4.348	TRO6-OFU-OT

Notes:

- Shipped assembled.
- If requested, shipped flat pack.
- Ready to assemble, no tools needed.
- Fumed colors will vary accross the table.
 Read more under material information.

Dimensions

Diameter	Ø120 cm
Height	73 cm
Solid Oak Table Top Thickness	2,6 cm
Box (top)	122 x 122 x 5 cm
Box (legs)	86 x 86 x 80 cm
Total Weight	54 kg

Seatings



HB Lounge Chair

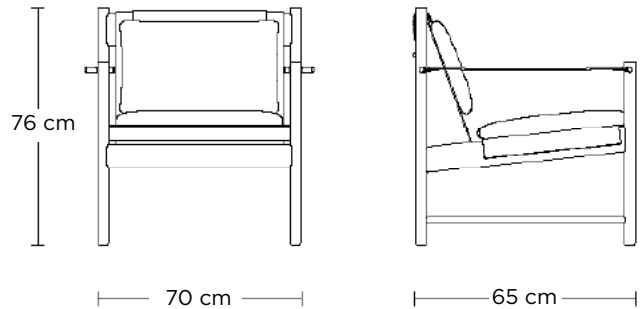

by Hans Bølling

HB Lounge Chair
Hans Bølling





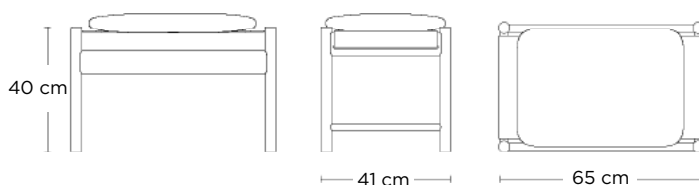

	Canvas frame / Canvas seat and backrest cushion	EURO ex. VAT	#Reference
	Oak, Oiled	2.558	BOCL-OOL
	Fumed Oak, Oiled	2.742	BOCL-OFU
	Maple, White Oiled	2.558	BOCL-MWL
	Cherry, Oiled	2.742	BOCL-COL

	Canvas frame / Leather seat and backrest cushion		
	Oak, Oiled	3.017	BOCL-OOL
	Fumed Oak, Oiled	3.201	BOCL-OFU
	Maple, White Oiled	3.017	BOCL-MWL
	Cherry, Oiled	3.201	BOCL-COL

Upholstery	# Reference	Dimensions	
 Canvas	06	Height	76 cm
 Spectrum, Brandy Leather - 30155	66	Width	70 cm
		Seat Depth	53,6 cm
		Seat Height	56,6 cm
		Box	74 x 72x 80 cm
		Weight	15 kg



	Canvas frame	EURO ex. VAT	#Reference
	Oak, Oiled	677	B040-OOL
	Fumed Oak, Oiled	856	BO40-OFU
	Maple, White Oiled	677	BO40-MWL
	Cherry, Oiled	856	BO40-COL

Cushion

HB Stool Cushion - Canvas Textile	122	BOCC-06
HB Stool Cushion - Spectrum, Brandy Leather	305	BOCC-66

Dimensions

Height	40 cm
Length	65 cm
Width	41 cm
Box	67 x 46 x 43 cm
Weight	4 kg



Arv Chair

by David Thulstrup

Arv Chair
David Thulstrup



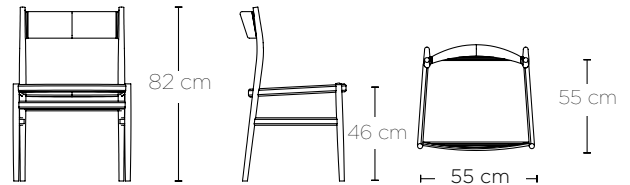

Weaved Seat, Weaved Back

EURO ex. VAT

#Reference

	Oak, White Oiled	1.224	AVCX-OWO-02
	Oak, Oiled	1.224	AVCX-OOL-02
	Fumed Oak, Oiled	1.377	AVCX-OFU-02

Weaved Seat, Solid Back

	Oak, White Oiled	1.224	AVCX-OWO-01
	Oak, Oiled	1.224	AVCX-OOL-01
	Fumed Oak, Oiled	1.377	AVCX-OFU-01

Notes:

- Available only for selected dealers.
- Approved for hotel / restaurant (EN 15372: 2016, Test level 2 General)
- Felt gliders.
- Fumed colors will vary across the chair as the wood content of tanin will vary.
Read more under material information.

Dimensions

Height	82 cm
Width	55 cm
Seat Height	46 cm
Seat Depth	45 cm
Box	63 x 59 x 90 cm
Weight	7 kg

Arv Dining Chair
David Thulstrup

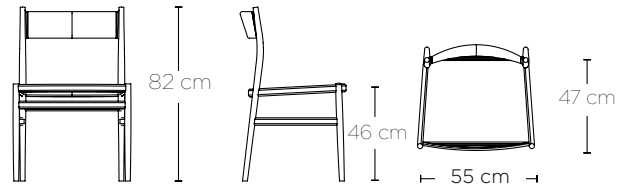

Leather Seat, Solid Back



EURO ex. VAT

#Reference

	Oak, White Oiled	1.071	AVCX-OWO
	Oak, Oiled	1.071	AVCX-OOL
	Fumed Oak, Oiled	1.224	AVCX-OFU

Upholstery

Reference

	Spectrum, Brandy Leather - 30155	66
	Spectrum, Cinnamon Leather - 30146	65

Dimensions

Height	82 cm
Width	55 cm
Seat Height	46 cm
Seat Depth	45 cm
Box	63 x 59 x 90 cm
Weight	7 kg

Notes:

- Available only for selected dealers.
- Approved for hotel / restaurant (EN 15372: 2016, Test level 2 General)
- Felt gliders.
- Fumed colors will vary across the chair as the wood content of tanin will vary.
Read more under material information.

ARV Dining Chair with Armrest
David Thulstrup

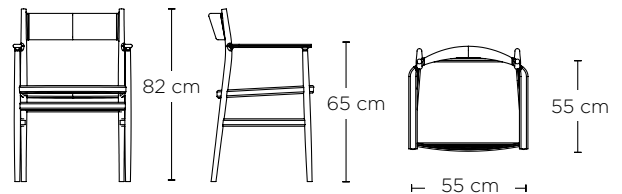

Weaved Seat, Weaved Back

	EURO ex. VAT	#Reference
 Oak, White Oiled	1.499	AVCA-OWO-02
 Oak, Oiled	1.499	AVCA-OOL-02
 Fumed Oak, Oiled	1.652	AVCA-OFU-02

Weaved Seat, Solid Back

 Oak, White Oiled	1.499	AVCA-OWO-01
 Oak, Oiled	1.499	AVCA-OOL-01
 Fumed Oak, Oiled	1.652	AVCA-OFU-01

Notes:

- Available only for selected dealers.
- Approved for hotel / restaurant (EN 15372: 2016, Test level 2 General)
- Felt gliders.
- Fumed colors will vary across the chair as the wood content of tanin will vary.
Read more under material information.



Dimensions

Height	82 cm
Width	55 cm
Seat Height	46 cm
Seat Depth	45 cm
Arm Height	65,3 cm
Box	63 x 59 x 90 cm
Weight	7,5 kg

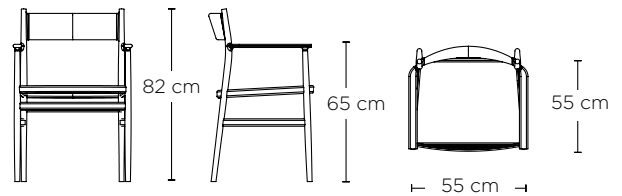
ARV Dining Chair with Armrest
David Thulstrup



	Leather Seat, Solid Back	EURO ex. VAT	#Reference
	Oak, White Oiled	1.346	AVCA-OWO
	Oak, Oiled	1.346	AVCA-OOL
	Fumed Oak, Oiled	1.499	AVCA-OFU

	Upholstery	# Reference
	Spectrum, Brandy Leather - 30155	66
	Spectrum, Cinnamon Leather - 30146	65

Dimensions	
Height	82 cm
Width	55 cm
Seat Height	46 cm
Seat Depth	45 cm
Arm Height	65,3 cm
Box	63 x 58 x 90 cm
Weight	7,5 kg

Notes:

- Available only for selected dealers.
- Approved for hotel / restaurant (EN 15372: 2016, Test level 2 General)
- Felt gliders.
- Fumed colors will vary across the chair as the wood content of tanin will vary.
Read more under material information.

Arv Lounge Chair
David Thulstrup

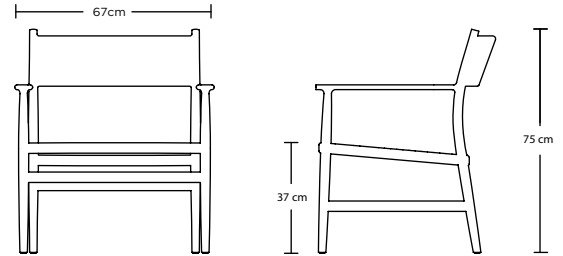

Weaved Seat, Weaved Back

EURO ex. VAT

#Reference

	Oak, White Oiled	2.962	AVCL-OWO-02
	Oak, Oiled	2.962	AVCL-OOL-02
	Fumed Oak, Oiled	3.176	AVCL-OFU-02

Notes:



- Available only for selected dealers.
- Approved for hotel / restaurant (EN 15372: 2016, Test level 2 General)
- Felt gliders.
- Fumed colors will vary across the chair as the wood content of tanin will vary.
Read more under material information.

Dimensions

Height	75 cm
Width	67 cm
Seat Depth	65 cm
Seat Height	37 cm
Box	74 x 72x 80 cm
Weight	15 kg



	EURO ex. VAT	#Reference
Arv Dining Chair Cushion	159	AVCC
Arv Lounge Chair Cushion	266	AVCC-LO

	Upholstery	# Reference
	Spectrum, Brandy Leather - 30155	66
	Spectrum, Cinnamon Leather - 30146	65



Arkade Chair

by Nanna Ditzel

Arkade Chair
Nanna Ditzel



 BRDR. KRÜGER





Arkade Dining Chair
Nanna Ditzel



Fabric	EURO ex. VAT	#Reference
 Oak, White Oiled	1.113	ARCA-OWO
 Oak, Oiled	1.113	ARCA-OOL
 Fumed Oak, Oiled	1.297	ARCA-OFU

Metal Frame Powder Coating	# Reference
 Black	BO
 Brass	BR
 Chrome	CH

Upholstery	# Reference
 Hallingdal, Grey Fabric - 0113	35
 Moss, Cream Fabric - 0019	33

Dimensions	
Height	78 cm
Width	56 cm
Seat Height	48 cm
Seat Depth	60 cm
Armrest Height	70 cm
Box	63 x 59 x 90 cm
Weight	10 kg



Notes:

- Felt gliders.
- Fumed colors will vary across the chair as the wood content of tanin will vary.
Read more under material information.





Arkade Dining Chair
Nanna Ditzel



Leather	EURO ex. VAT	#Reference
 Oak, White Oiled	1.572	ARCA-OWO
 Oak, Oiled	1.572	ARCA-OOL
 Fumed Oak, Oiled	1.756	ARCA-OFU

Metal Frame Powder Coating	# Reference
 Black	BO
 Brass	BR
 Chrome	CH

Dimensions	
Height	78 cm
Width	56 cm
Seat Height	48 cm
Seat Depth	60 cm
Armrest Height	70 cm
Box	63 x 59 x 90 cm
Weight	10 kg

Upholstery	# Reference
 Spectrum, Oyster Leather - 30157	62
 Spectrum, Almond Leather - 30150	63
 Spectrum, Brandy Leather - 30155	66
 Spectrum, Cinnamon Leather - 30146	65
 Savanne, Black Leather - 30314	61

Notes:

- Felt gliders.
- Fumed colors will vary across the chair as the wood content of tanin will vary.
Read more under material information.



Leather

EURO ex. VAT

#Reference



Oak, White Oiled, Chrome Frame, Beige Sheep Skin / Leather

2.142

ARCA-OWO-CH-67

Dimensions

Height	78 cm
Width	56 cm
Seat Height	48 cm
Seat Depth	60 cm
Armrest Height	70 cm
Box	63 x 59 x 90 cm
Weight	10 kg

Notes:

- Felt gliders.

Arkade Dining Chair
Nanna Ditzel



Wood Seat and Back

EURO ex. VAT

#Reference

	Oak, White Oiled	795	ARCA-OWO-03
	Oak, Oiled	795	ARCA-OOL-03
	Fumed Oak, Oiled	979	ARCA-OFU-03

Metal Frame Powder Coating

Reference

	Black	BO
	Brass	BR
	Chrome	CH

Dimensions

Height	78 cm
Width	56 cm
Seat Height	48 cm
Seat Depth	60 cm
Armrest Height	70 cm
Box	63 x 59 x 90 cm
Weight	8 kg

Notes:

- Felt gliders.
- Fumed colors will vary across the chair as the wood content of tanin will vary.
Read more under material information.



F Chair





by Rasmus B. Fex

F Chair
Rasmus B. Fex

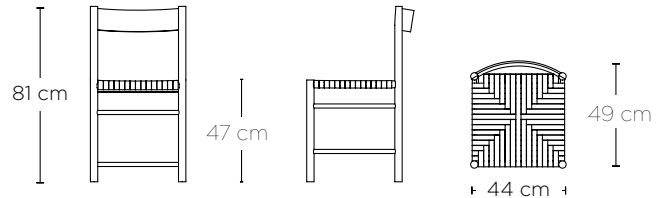

F Dining Chair
Rasmus B. Fex



		EURO ex. VAT	#Reference
	Oak, Oiled, Black Webbing Seat	599	FCCX-OOL-11
	Fumed Oak, Oiled, Natural Linen, Webbing Seat	660	FCCX-OFU-04
	Ash, Black Lacquer, Black Webbing Seat	660	FCCX-ABA-11
	Ash, Green Lacquer, Green Webbing Seat	660	FCCX-AGR-12
	Ash, Red Lacquer, Red Webbing Seat	660	FCCX-ARE-13

Notes:





- Approved for hotel / restaurant (EN 15372: 2016, Test level 2 General)
- Felt gliders.

Dimensions

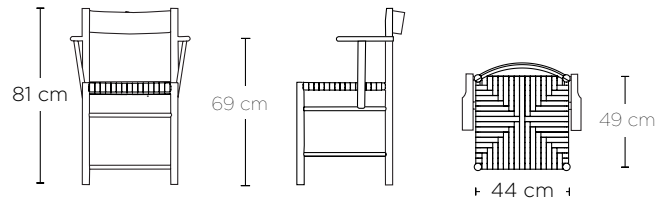
Height	81 cm
Width	44 cm
Seat Height	47 cm
Seat Width	44 cm
Box	50 x 50 x 83 cm
Weight	5 kg

F Dining Chair with Armrest
Rasmus B. Fex



	EURO ex. VAT	#Reference
 Oak, Oiled, Black Webbing Seat	768	FCCA-OOL-11
 Fumed Oak, Oiled, Natural Linen, Webbing Seat	829	FCCA-OFU-04
 Ash, Black Lacquer, Black Webbing Seat	829	FCCA-ABA-11
 Ash, Green Lacquer, Green Webbing Seat	829	FCCA-AGR-12
 Ash, Red Lacquer, Red Webbing Seat	829	FCCA-ARE-13

Notes:

- Approved for hotel / restaurant (EN 15372: 2016, Test level 2 General)
- Felt gliders.





Dimensions

Height	81 cm
Width	54,5 cm
Seat Height	45 cm
Seat Width	47 cm
Arm Height	69 cm
Box	53 x 59 x 84 cm
Weight	5,5 kg

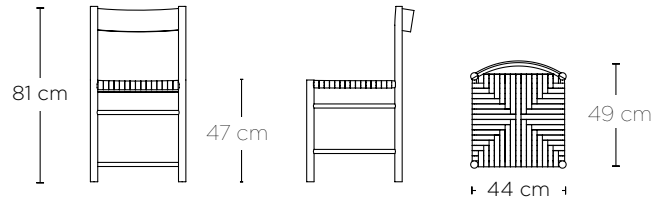
F Dining Chair with Paper Cord

Rasmus B. Fex



Paper Cord	EURO ex. VAT	#Reference
 Oak, Oiled	829	FCCX-OOL-01
 Fumed Oak, Oiled	890	FCCX-OFU-01
 Ash, Black Lacquer	890	FCCX-ABA-01
 Ash, Green Lacquer	890	FCCX-AGR-01
 Ash, Red Lacquer	890	FCCX-ARE-01

Notes:

- Approved for hotel / restaurant use:
EN 1022:2005, EN 16139:2013
- Felt gliders.
- Seat in paper cord.
The weaving is a traditional Danish triangle shape used for generations. Since cords need to overlap it is not possible to make four triangles that meet exactly in the middle - they will always overlap. Also, the four lines going from the edge of the seat to the center will never be 100 pct. straight. This is a handmade product and part of the character of the chair.





Dimensions

Height	81 cm
Width	44 cm
Seat Height	47 cm
Seat Width	44 cm
Box	50 x 50 x 83 cm
Weight	5 kg

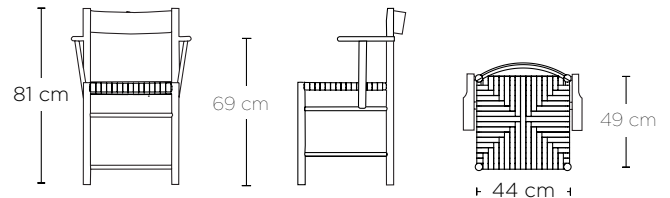
F Dining Chair with Armrest and Paper Cord

Rasmus B. Fex



Paper Cord	EURO ex. VAT	#Reference
 Oak, Oiled	997	FCCA-OOL-01
 Fumed Oak, Oiled	1.058	FCCA-OFU-01
 Ash, Black Lacquer	1.058	FCCA-ABA-01
 Ash, Green Lacquer	1.058	FCCA-AGR-01
 Ash, Red Lacquer	1.058	FCCA-ARE-01

Notes:

- Approved for hotel / restaurant use:
EN 1022:2005, EN 16139:2013
- Felt gliders.
- Seat in paper cord.
The weaving is a traditional Danish triangle shape used for generations. Since cords need to overlap it is not possible to make four triangles that meet exactly in the middle - they will always overlap. Also, the four lines going from the edge of the seat to the center will never be 100 pct. straight. This is a handmade product and part of the character of the chair.

Dimensions

Height	81 cm
Width	54,5 cm
Seat Height	45 cm
Seat Width	47 cm
Arm Height	69 cm
Box	53 x 59 x 84 cm
Weight	5,5 kg



Pauline Bar Stool





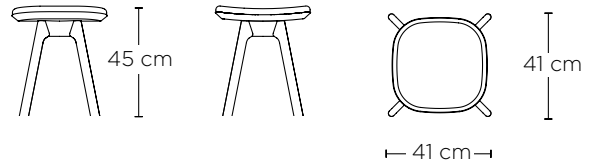

by OEO Studio





Fabric	EURO ex. VAT	#Reference
 Oak, Oiled	630	PA45-OOL
 Fumed Oak, Oiled	722	PA45-OFU
 Oak, Black Lacquer	722	PA45-OBA

Leather	EURO ex. VAT	#Reference
 Oak, Oiled	722	PA45-OOL
 Fumed Oak, Oiled	813	PA45-OFU
 Oak, Black Lacquer	813	PA45-OBA

Upholstery	# Reference	Dimensions
 Hallingdal, Grey Fabric - 0113	35	Height 45 cm
 Moss, Cream Fabric - 0019	33	Seat Width 36 cm
 Spectrum, Oyster Leather - 30157	62	Seat Depth 36 cm
 Spectrum, Almond Leather - 30150	63	Box 42 x 42 x 50 cm
 Spectrum, Brandy Leather - 30155	66	Weight 5 kg
 Spectrum, Cinnamon Leather - 30146	65	
 Savanne, Black Leather - 30314	61	





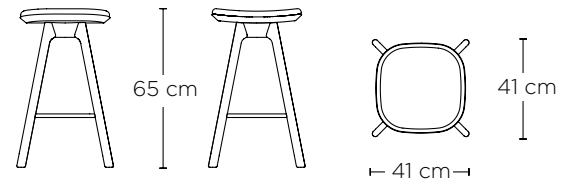

Note:

- Approved for hotel / restaurant use:
EN 1022:2005, EN 16139:2013.
- Plastic glider.



Fabric	EURO ex. VAT	#Reference
 Oak, Oiled	936	PA65-OOL
 Fumed Oak, Oiled	1.028	PA65-OFU
 Oak, Black Lacquer	1.028	PA65-OBA

Leather	EURO ex. VAT	#Reference
 Oak, Oiled	1.028	PA65-OOL
 Fumed Oak, Oiled	1.119	PA65-OFU
 Oak, Black Lacquer	1.119	PA65-OBA



Upholstery	# Reference	Dimensions
 Hallingdal, Grey Fabric - 0113	35	Height 65 cm
 Moss, Cream Fabric - 0019	33	Seat Width 36 cm
 Spectrum, Oyster Leather - 30157	62	Seat Depth 36 cm
 Spectrum, Almond Leather - 30150	63	Box 42 x 42 x 70 cm.
 Spectrum, Brandy Leather - 30155	66	Weight 6 kg
 Spectrum, Cinnamon Leather - 30146	65	
 Savanne, Black Leather - 30314	61	

Note:







- Approved for hotel / restaurant use:
EN 1022:2005, EN 16139:2013.
- Plastic glider.

Pauline Comfort Bar Stool 65 cm
OEO Studio



Fabric	EURO ex. VAT	#Reference
 Oak, Oiled	1.303	PA66-OOL
 Fumed Oak, Oiled	1.395	PA66-OFU
 Oak, Black Lacquer	1.395	PA66-OBA

Leather	EURO ex. VAT	#Reference
 Oak, Oiled	1.395	PA66-OOL
 Fumed Oak, Oiled	1.487	PA66-OFU
 Oak, Black Lacquer	1.487	PA66-OBA

Upholstery	# Reference	Dimensions
 Hallingdal, Grey Fabric - 0113	35	Height 95 cm
 Moss, Cream Fabric - 0019	33	Seat Height 65 cm
 Spectrum, Oyster Leather - 30157	62	Seat Width 36 cm
 Spectrum, Almond Leather - 30150	63	Seat Depth 36 cm
 Spectrum, Brandy Leather - 30155	66	Box 49 x 49 x 100 cm.
 Spectrum, Cinnamon Leather - 30146	65	Weight 8 kg
 Savanne, Black Leather - 30314	61	







- Note:**
- Approved for hotel / restaurant use: EN 1022:2005, EN 16139:2013.
 - Plastic glider.

Pauline Bar Stool 65 cm with metal legs
OEO Studio



Fabric	EURO ex. VAT	#Reference
 Oak, Oiled	709	PA65-OOL-BM
 Fumed Oak, Oiled	801	PA65-OFU-BM
 Oak, Black Lacquer	801	PA65-OBA-BM

Leather	EURO ex. VAT	#Reference
 Oak, Oiled	801	PA65-OOL-BM
 Fumed Oak, Oiled	893	PA65-OFU-BM
 Oak, Black Lacquer	893	PA65-OBA-BM

Upholstery	# Reference
 Hallingdal, Grey Fabric - 0113	35
 Moss, Cream Fabric - 0019	33
 Spectrum, Oyster Leather - 30157	62
 Spectrum, Almond Leather - 30150	63
 Spectrum, Brandy Leather - 30155	66
 Spectrum, Cinnamon Leather - 30146	65
 Savanne, Black Leather - 30314	61

Dimensions	
Height	65 cm
Seat Width	36 cm
Seat Depth	36 cm
Box	42 x 42 x 70 cm.
Weight	7,5 kg







Note:

- Approved for hotel / restaurant use: EN 1022:2005, EN 16139:2013.
- Plastic glider.
- Steel legs and footrest, powder coated matt black.



Fabric	EURO ex. VAT	#Reference
 Oak, Oiled	1.077	PA66-OOL-BM
 Fumed Oak, Oiled	1.168	PA66-OFU-BM
 Oak, Black Lacquer	1.168	PA66-OBA-BM

Leather	EURO ex. VAT	#Reference
 Oak, Oiled	1.168	PA66-OOL-BM
 Fumed Oak, Oiled	1.260	PA66-OFU-BM
 Oak, Black Lacquer	1.260	PA66-OBA-BM

Upholstery	# Reference	Dimensions
 Hallingdal, Grey Fabric - 0113	35	Height 95 cm
 Moss, Cream Fabric - 0019	33	Seat Height 65 cm
 Spectrum, Oyster Leather - 30157	62	Seat Width 36 cm
 Spectrum, Almond Leather - 30150	63	Seat Depth 36 cm
 Spectrum, Brandy Leather - 30155	66	Box 49 x 49 x 100 cm.
 Spectrum, Cinnamon Leather - 30146	65	Weight 9,5 kg
 Savanne, Black Leather - 30314	61	

Note:

- Approved for hotel / restaurant use: EN 1022:2005, EN 16139:2013.
- Plastic glider.
- Steel legs and footrest, powder coated matt black.

Pauline Bar Stool 65 cm with wooden seat
OEO Studio



	EURO ex. VAT	#Reference
 Oak, Oiled	563	PA65-OOL-BM-05
 Fumed Oak, Oiled	654	PA65-OFU-BM-05
 Oak, Black Lacquer	654	PA65-OBA-BM-05

Note:

- Approved for hotel / restaurant use:
EN 1022:2005, EN 16139:2013.
- Plastic glider.
- Steel legs and footrest, powder coated matt black.
- Seat in solid oak.

Dimensions





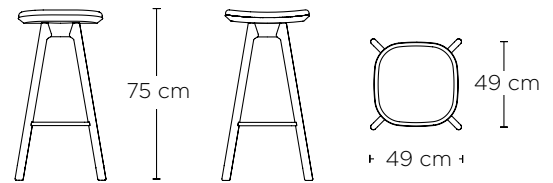

Height	65 cm
Seat Width	36 cm
Seat Depth	36 cm
Box	42 x 42 x 70 cm
Weight	8 kg

Pauline Bar Stool 75 cm
OEO Studio



Fabric	EURO ex. VAT	#Reference
 Oak, Oiled	936	PA75-OOL
 Fumed Oak, Oiled	1.028	PA75-OFU
 Oak, Black Lacquer	1.028	PA75-OBA

Leather	EURO ex. VAT	#Reference
 Oak, Oiled	1.028	PA75-OOL
 Fumed Oak, Oiled	1.119	PA75-OFU
 Oak, Black Lacquer	1.119	PA75-OBA

Upholstery	# Reference
 Hallingdal, Grey Fabric - 0113	35
 Moss, Cream Fabric - 0019	33
 Spectrum, Oyster Leather - 30157	62
 Spectrum, Almond Leather - 30150	63
 Spectrum, Brandy Leather - 30155	66
 Spectrum, Cinnamon Leather - 30146	65
 Savanne, Black Leather - 30314	61

Dimensions	
Height	75 cm
Seat Width	36 cm
Seat Depth	36 cm
Box	49 x 49 x 80 cm
Weight	6,5 kg

Note:





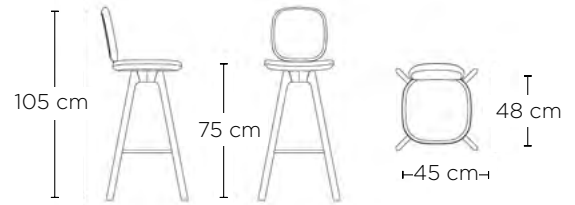

- Approved for hotel / restaurant use: EN 1022:2005, EN 16139:2013.
- Plastic glider.
- Steel legs and footrest, powder coated matt black.

Pauline Comfort Bar Stool 75 cm
OEO Studio



Fabric	EURO ex. VAT	#Reference
 Oak, Oiled	1.303	PA76-OOL
 Fumed Oak, Oiled	1.395	PA76-OFU
 Oak, Black Lacquer	1.395	PA76-OBA

Leather	EURO ex. VAT	#Reference
 Oak, Oiled	1.395	PA76-OOL
 Fumed Oak, Oiled	1.487	PA76-OFU
 Oak, Black Lacquer	1.487	PA76-OBA

Upholstery	# Reference	Dimensions
 Hallingdal, Grey Fabric - 0113	35	Height 105 cm
 Moss, Cream Fabric - 0019	33	Seat Height 75 cm
 Spectrum, Oyster Leather - 30157	62	Seat Width 36 cm
 Spectrum, Almond Leather - 30150	63	Seat Depth 36 cm
 Spectrum, Brandy Leather - 30155	66	Box 49 x 49 x 110 cm
 Spectrum, Cinnamon Leather - 30146	65	Weight 8,5 kg
 Savanne, Black - Leather 30314	61	







- Note:**
- Approved for hotel / restaurant use: EN 1022:2005, EN 16139:2013.
 - Plastic glider.

Pauline Bar Stool 75 cm metal legs
OEO Studio



Fabric	EURO ex. VAT	#Reference
 Oak, Oiled	709	PA75-OOL-BM
 Fumed Oak, Oiled	801	PA75-OFU-BM
 Oak, Black Lacquer	801	PA75-OBA-BM

Leather	EURO ex. VAT	#Reference
 Oak, Oiled	801	PA75-OOL-BM
 Fumed Oak, Oiled	893	PA75-OFU-BM
 Oak, Black Lacquer	893	PA75-OBA-BM

Upholstery	# Reference
 Hallingdal, Grey Fabric - 0113	35
 Moss, Cream Fabric - 0019	33
 Spectrum, Oyster Leather - 30157	62
 Spectrum, Almond Leather - 30150	63
 Spectrum, Brandy Leather - 30155	66
 Spectrum, Cinnamon Leather - 30146	65
 Savanne, Black Leather - 30314	61

Dimensions	
Height	75 cm
Seat Width	36 cm
Seat depth	36 cm
Box	49 x 49 x 80 cm
Weight	8 kg

Note:





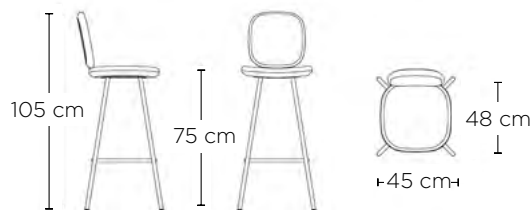

- Approved for hotel / restaurant use: EN 1022:2005, EN 16139:2013.
- Plastic glider.
- Steel legs and footrest, powder coated matt black.

Pauline Comfort Bar Stool 75 cm metal legs
OEO Studio



Fabric	EURO ex. VAT	#Reference
 Oak, Oiled	1.077	PA76-OOL-BM
 Fumed Oak, Oiled	1.168	PA76-OFU-BM
 Oak, Black Lacquer	1.168	PA76-OBA-BM

Leather	EURO ex. VAT	#Reference
 Oak, Oiled	1.168	PA76-OOL-BM
 Fumed Oak, Oiled	1.260	PA76-OFU-BM
 Oak, Black Lacquer	1.260	PA76-OBA-BM

Upholstery	# Reference	Dimensions
 Hallingdal, Grey Fabric - 0113	35	Height 105 cm
 Moss, Cream Fabric - 0019	33	Seat Height 75 cm
 Spectrum, Oyster Leather - 30157	62	Seat Width 36 cm
 Spectrum, Almond Leather - 30150	63	Seat Depth 36 cm
 Spectrum, Brandy Leather - 30155	66	Box 49 x 49 x 110 cm
 Spectrum, Cinnamon Leather - 30146	65	Weight 9,5 kg
 Savanne, Black Leather - 30314	61	

- Note:**
- Approved for hotel / restaurant use: EN 1022:2005, EN 16139:2013.
 - Plastic glider.
 - Steel legs and footrest, powder coated matt black.

Pauline Barstol 75 cm with wooden seat
OEO Studio



	EURO ex. VAT	#Reference
 Oak, Oiled	563	PA75-OOL-BM-05
 Fumed Oak, Oiled	654	PA75-OFU-BM-05
 Oak, Black Lacquer	654	PA75-OBA-BM-05

Note:

- Approved for hotel / resturant use:
EN 1022:2005, EN 16139:2013.
- Plastic glider.
- Steel legs and footrest, powder coated matt black.
- Seat in solid oak.

Dimensions

Height	75 cm
Seat Width	36 cm
Seat Depth	36 cm
Box	49 x 49 x 80 cm
Weight	8,5 kg







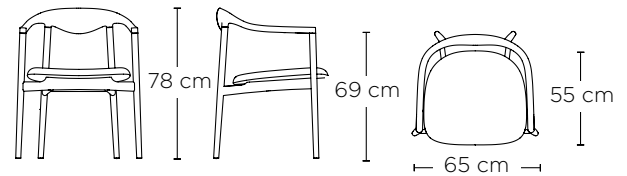



Jari Chair

by OEO Studio



Fabric	EURO ex. VAT	#Reference
 Ash, Black Lacquer	1.860	JACA-ABA
 Oak, Oiled	1.768	JACA-OOL
 Fumed Oak, Oiled	1.860	JACA-OFU

Leather	EURO ex. VAT	#Reference
 Ash, Black Lacquer	2.227	JACA-ABA
 Oak, Oiled	2.136	JACA-OOL
 Fumed Oak, Oiled	2.227	JACA-OFU

Upholstery	# Reference	Dimensions
 Hallingdal, Grey Fabric - 0113	35	Height 78 cm
 Moss, Cream Fabric - 0019	33	Width 65 cm
 Spectrum, Oyster Leather - 30157	62	Seat Height 46 cm
 Spectrum, Almond Leather - 30150	63	Seat Depth 50 cm
 Spectrum, Brandy Leather - 30155	66	Armrest Height 69 cm
 Spectrum, Cinnamon Leather - 30146	65	Box 67 x 63 x 80 cm
 Savanne, Black Leather - 30314	61	Weight 10 kg

Notes:

- Felt gliders.
- Fumed colors will vary across the chair as the wood content of tanin will vary.







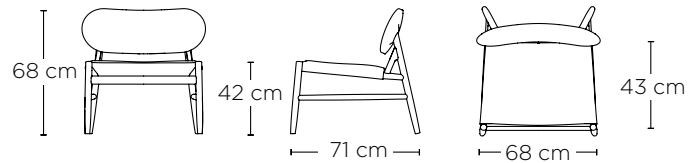

Ferdinand Lounge Chair

by OEO Studio



Fabric	EURO ex. VAT	#Reference
 Oak, Oiled	2.946	FECX-OOL
 Fumed Oak, Oiled	3.130	FECX-OFU
 Oak, Black Lacquer	3.130	FECX-OBA

Leather	EURO ex. VAT	#Reference
 Oak, Oiled	3.175	FECX-OOL
 Fumed Oak, Oiled	3.359	FECX-OFU
 Oak, Black Lacquer	3.359	FECX-OBA

Upholstery	# Reference	Dimensions
 Hallingdal, Grey Fabric - 0113	35	Height 68 cm
 Moss, Cream Fabric - 0019	33	Width 68 cm
 Spectrum, Oyster Leather - 30157	62	Seat Depth 43 cm
 Spectrum, Almond Leather - 30150	63	Seat Height 42 cm
 Spectrum, Brandy Leather - 30155	66	Box 74 x 72x 80 cm
 Spectrum, Cinnamon Leather - 30146	65	Weight 15 kg
 Savanne, Black Leather - 30314	61	

Notes:

- Felt gliders.
- Fumed colors will vary across the chair as the wood content of tanin will vary.



Karm Sofa

by David Thulstrup

Karm Lounge Chair
David Thulstrup

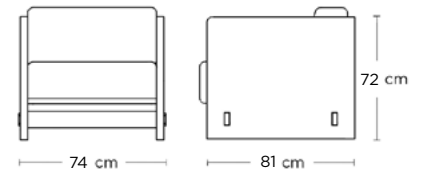

	EURO ex. VAT	#Reference
 Oak, Oiled	5.184	KA1S-OOL
 Fumed Oak, Oiled	5.490	KA1S-OFU

Upholstery	# Reference
 Hallingdal, Grey Fabric - 0113	35
 Moss, Cream Fabric - 0019	33

Dimensions	
Length	74 cm
Height	72 cm
Width	81 cm
Seat Depth	57 cm
Seat Height	42 cm



Notes:

- The very core of the KARM sofa's design comes from the strong variation in the wood that makes every piece unique. Some sofas have small or large knots and some will have a strong grain texture while others will have less.

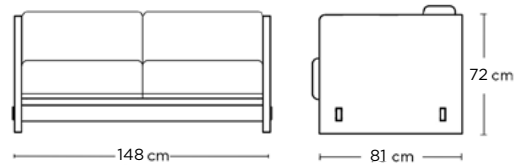
Karm Sofa 2 Seaters
David Thulstrup



	EURO ex. VAT	#Reference
 Oak, Oiled	7.449	KA2S-OOL
 Fumed Oak, Oiled	8.061	KA2S-OFU

Upholstery	# Reference
 Hallingdal, Grey Fabric - 0113	35
 Moss, Cream Fabric - 0019	33

Dimensions	
Length	148 cm
Height	72 cm
Width	81 cm
Seat Depth	57 cm
Seat Height	42 cm

Notes:

- The very core of the KARM sofa's design comes from the strong variation in the wood that makes every piece unique. Some sofas have small or large knots and some will have a strong grain texture while others will have less.

Karm Sofa 3 Seaters
David Thulstrup

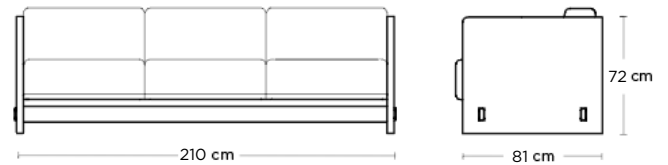

	EURO ex. VAT	#Reference
 Oak, Oiled	9.499	KA3S-OOL
 Fumed Oak, Oiled	10.111	KA3S-OFU

Upholstery	# Reference
 Hallingdal, Grey Fabric - 0113	35
 Moss, Cream Fabric - 0019	33

Dimensions	
Length	210 cm
Height	72 cm
Width	81 cm
Seat Depth	57 cm
Seat Height	42 cm

Notes:

- The very core of the KARM sofa's design comes from the strong variation in the wood that makes every piece unique. Some sofas have small or large knots and some will have a strong grain texture while others will have less.

Lighting



Lune Lamp

by Sverre Uhnger

Lune Table Lamp
Sverre Uhnger

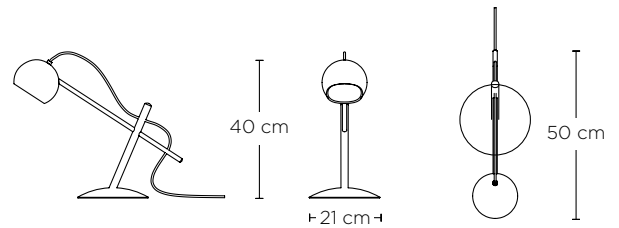

	EURO ex. VAT	#Reference
 Oak, White Oiled, White Electric Cord	734	LUTL-OWO
 Oak, Oiled, Black Electric Cord	734	LUTL-OOL
 Fumed Oak, Oiled, Black Electric Cord	826	LUTL-OFU

Notes:

- Bulb is not included.
- * LED bulb GU 10, max 6 watt.
- * Only approved for EU area.

Dimensions

Length	50 cm
Height	40 cm
Shade	Ø 14 cm
Box	21 cm
Base	59 x 39 x 24 cm
Weight	4 kg

Lune Pendant Lamp
Sverre Uhnger

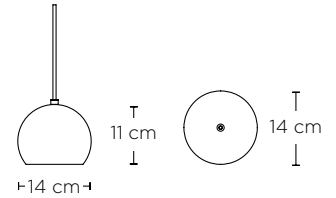

	EURO ex. VAT	#Reference
 Oak, White Oiled, White Electric Cord	428	LUPE-OWO
 Oak, Oiled, Black Electric Cord	428	LUPE-OOL
 Fumed Oak, Oiled, Black Electric Cord	428	LUPE-OFU

Notes:

- Bulb is not included.
- * LED bulb GU 10, max 6 watt.
- * Only approved for EU area.

Dimensions

Shade	Ø 14 cm
Wire	3 m
Box	20 x 20 x 26 cm
Weight	0,7 kg

Complements



	EURO ex. VAT	#Reference
Beech, Lacquer	428	MOXX-BLA

Dimensions

Height	49 cm
Width	62 cm
Box	64 x 52 x 29 cm
Weight	10 kg



	EURO ex. VAT	#Reference
Stainless Steel, Tempered Glass	2.504	OMS2-CG

Notes:

- Shipped flat packed.
- Must be assembled, tools are included.
- Loose trays.

Dimensions

Length	75 cm
Width	42 cm
Height	80 cm
Box	82 x 50 x 16 cm
Weight	25 kg



	EURO ex. VAT	#Reference
Complete Sample Box	183	KCSB
Leather Sample Set	42	KCLES
Fabric Sample Set	20	KCTS
Wooden Sample (each piece)	12	KCWS
Compact Laminate Set	42	KCLAS
Metal Sample Set	42	KCMS
Webbing Sample Set	10	KCGS

General information



Employees

We employ a variety of people with different backgrounds, education, ethnicity, age and gender.



Education

We employ a large number of trainees and apprentices to support the industry's future.



Union

We follow the collective agreement for the largest trade union in Denmark (3F) to secure workers' rights in the production team.



Safety

Our health and safety regulation are audited on a regular basis by the Danish Working Authority.



Insurance

We offer extra health insurance for our employees and their families.



Wood

We only use certified wood - FSC © or PEFC ©.



Wind Power

Our factory buys electricity from suppliers, where the greatest possible electricity comes from Danish wind farms. This means that we only buy certified Co2 neutral electricity.



Heating

We use waste wood to generate heat - minimizing our carbon footprint.



Local

We prioritize local suppliers to minimize transport emissions.



Packaging

We only use recyclable cardboard and plastic in packaging.



Wood

Wood & Treatments

We use only certified wood from high quality suppliers. Our craftsmen choose carefully the wood for each piece of furniture. Selected wood sorts for each piece of furniture can be seen under product pages. Please note that all the models are not available in all species.



Natural Oak

North European Oak is mostly straight grained with a medium to coarse texture. It is widely used in Scandinavian furniture because of its strength.



Black Painted Oak

Paint with a semi matt finish. The grains of the oak is still visible. The top coat gives a hard protection and seals the wood.



Fumed Oak

We “home fume” every piece of furniture in our work shop. Every log has different reaction to the fuming so the color varies across each furniture.



Natural Beech

The grain of the natural beech is straight, with a fine to medium uniform texture. It is strong and durable with a good resistance to abrasion.



Oak White Oiled

Light pigments give the grains a brighter tint. It is water-repellent, dirt-resistant and durable.



Oiled Beech

Oil is developed from natural oils and waxes to provide the most durable protection. It brings out the warmth and depth of the wood.



Oiled Oak

Oil is developed from natural oils and waxes to provide the most durable protection. It brings out the warmth and depth of the wood.

Wood



White Oiled Ash

Ash will become yellow over time. To prevent this, we use white pigmented wax as a finish.

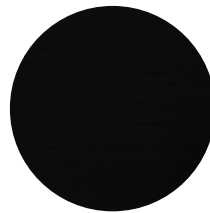

Black Lacquered Ash

The colour and a polyurethane top coat is applied to give a semi matt finish. Lacquered ash is durable and resistant against water, moist and heat.



Red Lacquered Ash

The colour and a polyurethane top coat is applied to give a semi matt finish. Lacquered ash is durable and resistant against water, moist and heat.



Green Lacquered Ash

The colour and a polyurethane top coat is applied to give a semi matt finish. Lacquered ash is durable and resistant against water, moist and heat.



Oiled Walnut

We use an American walnut because of its luxurious dark brown colour and its grain is revealed by a wax oil treatment.



Blue Lacquered Ash

The colour and a polyurethane top coat is applied to give a semi matt finish. Lacquered ash is durable and resistant against water, moist and heat.



Oiled Cherry

American cherry is a supreme hardwood species from the U.S. hardwood forests and is unique to North America, with warm colour tones and superb finishing qualities.



White Oiled Maple

Growing naturally in the hardwood forests of North America, Maple is one of the most prolific and sustainable species with creamy to pale reddish brown and grained with a fine texture.

Compact Laminate

Compact laminate is made of special paper compressed into a firm tabletop in the process of high pressure and heat. We only use certified compact laminate of the highest quality, which our craftsmen carefully select for Bølling Tray Table. Each side of the compact laminate has a different colour. Each colour combination is selected to suit all the types of wood we use for Bølling Tray Table.

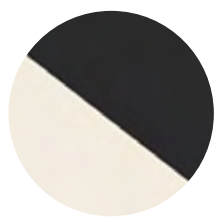

BASE

The classic model with Black and White trays has been discretely adjusted for softer contrast and a bit of warmth.



WATER

A deep marine Blue note that, like an anchor, brings calm and soothing tones to any context. On the reverse side of Water, is a brighter airy Blue, that uplifts with light contrast and tone-in-tone variation.



STONE

Two classic shades of slightly warm Grey, that will compliment most settings. Each side of Stone has its own light and dark grey. In combination they bring subtle and soft contrasts.



SUNNY

The warm Ochre Yellow is a reminiscent of ancient pigment colours, yet with vibrant energy. On the other side of the reversible tray, Sunny has a light creamy tone, that adds contrast and variation.



EARTH

A light caramel Beige that perfectly matches the natural tones of the oakwood frame, and comes across as monochrome, warm and modern. On the other side of the reversible tray, Earth has a dark chocolate Brown.

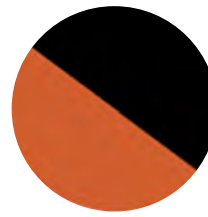

CLAY

This vibrant burnt Orange has classic notes of terracotta and cognac leather, both complementing and uplifting its interior context. On the other side of the tray, Clays has an off-Black.



LEAF

Two shades of green make up the Leaf colourway. On one side of the tray is a deep dark moss-like Green, and on the other; a lighter olive Green. In combination, the two greens complement each other with soft contrast.



RED

The warm red and black provide a classic contrast and variation that both complementing and uplifting its interior context.





Upholstery

Fabric

We create a simple selection of fabrics and leather from the world's best producers considering the quality, sustainability, ethics and safety of their products. All the leathers are chosen carefully from [Sørensen Leather](#) which are originated from European rawhide and fabric from [Kvadrat](#).



Moss by Sahco , 0019 [Kvadrat](#)

Sand
Designed by Vincent van Duysen
and Anna Vilhelmine Ebbesen.
Produced in Belgium.
52% cotton 22% viscose 14%
polyacrylic 6% linen 3% nylon 3%
polyester (worsted), 5% nylon.
50.000 Martindale

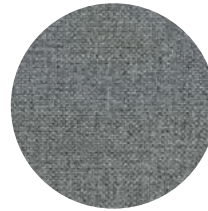

Hallingdal 65, 0113 [Kvadrat](#)

Grey
Designet byNanna Ditzel
Produced in Norge.
70% wool, 30 % viscose.
100.000 Martindale



Leather

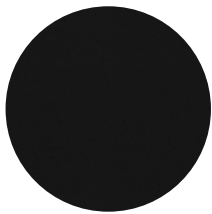

Savanne, 30314
[Sørensen Leather](#)

Black
Aniline Leather
Surface: Natural markings are part of the appeal
Finish Elegant matt with a soft, silky, velvety feel.

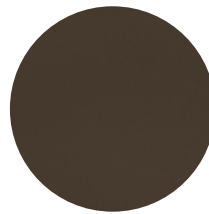

Spectrum, 30146
[Sørensen Leather](#)

Cinnamon
Aniline Leather
Surface: Natural markings are part of the appeal
Finish Elegant matt with a soft, silky, velvety feel.



Spectrum, 30155
[Sørensen Leather](#)

Brandy
Aniline Leather
Surface: Natural markings are part of the appeal
Finish Elegant matt with a soft, silky, velvety feel.

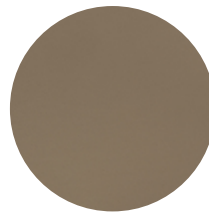

Spectrum, 30150
[Sørensen Leather](#)

Almond
Aniline Leather
Surface: Natural markings are part of the appeal
Finish Elegant matt with a soft, silky, velvety feel.

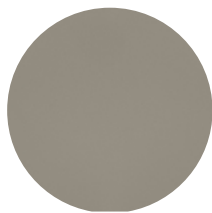

Spectrum, 30157
[Sørensen Leather](#)

Oyster
Aniline Leather
Surface: Natural markings are part of the appeal
Finish Elegant matt with a soft, silky, velvety feel.



Custom Upholstery Solutions

For Custom upholstery options, we charge the same price as the basic model of each product. The customer would be responsible for supplying or paying for the fabric or leather. The measurements are based on following standards:
Fabric with 146 cm, width and 5m² leather skin.

Product	Fabric per piece	Leather per piece
JARI	75 cm	0,8 m ²
ARV	75 cm	0,8 m ²
ARKADE	110 cm	1,3 m ²
PAULINE	45 cm	0,2 m ²
PAULINE COMFORT	45 cm	0,7 m ²
FERDINAND	75 cm	0,8 m ²
KARM Lounge	2 m	X
KARM Sofa 2 seater	4 m	X
KARM Sofa 3 seater	6 m	X

General Terms & Conditions

How to order

Send an e-mail to info@brdr-kruger.dk

- Please write "order" in subject line
- Write amount
- Write Product number as mentioned in the price list
- Write Upholstery Reference as mentioned in the price list
- if applicable.

You will receive an order confirmation (OC) within a few days. Please read carefully.

In the confirmation you will find the date when the product will be finalised. We ship on Thursday and Friday in the week mentioned on the OC.

If you do not want to pick up the goods, please let us know and we can assist with freight.

Delivery time

Average production time is:

Tray tables:	4 weeks
All other furniture:	8-14 weeks

Please ask for updated delivery times.

Currency & Effective Date

This price list is valid from 01.01.2024 and cancels all prior price lists.

Reservation is made for any errors and omissions.

Furthermore, below general terms and conditions shall apply to all contracts under which Brdr. Krüger A/S (Brdr. Krüger) is the supplier/subsupplier.

Order Confirmation

Orders shall not be binding on Brdr. Krüger until the customer has received Brdr. Krüger's written order confirmation.

Order Cancellation

Orders can be cancelled in accordance with the below rules:

Orders cancelled 0-5 days after order confirmation has been sent: no fee

Orders cancelled later than 5 days after order confirmation has been sent: fee: 15% of net price excl. VAT

Delivery

All items are sold ex works: The goods must be collected from Brdr. Krüger's address no later than 20 calendar days after the confirmed shipping date of the complete order.

If the goods are not collected according to the above, Brdr. Krüger charge a fee of 20 DKK / 3 EURO per. day per packages.

If the customer wants it, Brdr. Krüger can arrange the delivery.

Complaints

The physical product must be inspected upon delivery.

Damage incurred in transit as well as any defects and deficiencies on the product incurred as a result of transportation must be recorded on the freight bill upon delivery. Brdr. Krüger must be notified in writing of any complaints about product defects and deficiencies within 24 hours of delivery. If the complaint is made in due time and with the acceptance of Brdr. Krüger, the customer is entitled to demand a replacement delivery or to have the defect remedied. The customer cannot demand a reduction or a compensation. Complaints/replacements can only be made to the customer's address, unless delivery has been made directly to the end consumer.

Terms Of Payment

Unless otherwise agreed, payment must be made before the item is shipped. New customers always pay 14 days before the item is shipped. Customer orders must always be paid upon receipt of OC Brdr. Krüger may decide that the customer must pay in advance if the customer's balance is due, has previously been due or if the order amount exceeds Brdr. Krüger approved credit limit. In the event of non-payment after the deadline, a fee of DKK 150 excluding VAT will be added for the 1st and 2nd reminders. Then interest is calculated at 1.5% per—month from the due date. If there is no payment after the 3rd reminder, the case is transferred to debt collection.

Observation Of Title

Title to the goods shall not pass to the customer until Brdr. Krüger (or any third party to whom Brdr. Krüger has assigned its rights to the purchase price) has received the full purchase price and been reimbursed any expenses incurred.

Limitation Of Liability

Brdr. Krüger will assume no liability for any loss as a result of delays, defects or any other breach of contract, unless such loss was caused by gross negligence on the part of Brdr. Krüger. Brdr. Krüger will assume no liability for any indirect loss, including loss of profits, operating loss, goodwill, loss of customers, running costs or any other consequential economic loss.

Choice Of Law And Jurisdiction

Disputes between Brdr. Krüger and its customers shall be subject to Danish law, except for the international civil law rules of Danish law, and shall be settled by Brdr. Krüger's home court.

Measurements

The stated measurements in this document act only as a guideline. The measurements can vary and size difference on a product can occur.

The commercial warranty applicable to Brdr. Krüger products covers material and manufacturing process defects.

Products are under warranty for a period of 5 years as of the date of invoice sent to the original purchaser. The warranty is granted solely to the original purchaser of the product and is not transferable, either directly or indirectly, to any third party.

In accordance with this warranty, Brdr. Krüger undertakes to repair or replace with a similar product, according to its own criteria and free of charge, any product with any of the defects indicated above, provided that these arise under normal conditions of use.

These conditions are described in our "Care and maintenance" manual.

Exceptions To The Warranty

Upholsteries: Brdr. Krüger products include a variety of collections of upholsteries. Each of them is intended for a specific use and subject to the conditions of guarantee given by the manufacturer of them.

Exclusions To The Warranty

- Natural wear or wear caused by: unsuitable use, excessive scratching/scraping, sliding of objects on the surface, use of abrasive products, placing extremely hot or cold objects on the surface and use for which the product is not intended, on any surface finish and particularly when lacquered, varnished or melamine products are involved.
- Damage caused by mishandling of the products, produced directly or indirectly, as a result of the acts or omission of the Customer/Distributor, be it through fault or neglect. Amongst other things, blows, accidents, inexpert product assembly and installation, dragging products which do not incorporate rolling elements, sitting on tables, etc.
- Leaving the products at unsuitable locations exposed to extreme changes of temperature and/or humidity: in the vicinity of points at which heat or cold are generated, near humidifiers, etc.; and at locations exposed to the open air.
- Defects caused by unsuitable cleaning of the products (wrong methods or products, use of abrasive products), in violation of Brdr. Krüger's recommended guidelines.
- Defects caused by not cleaning or protecting (wood, lacquer, etc.) the products, not removing material or liquids which may immediately damage the surface, etc.
- Damage caused by unsuitable modifications to or operations on the products, or repair work performed by the Customer itself or a third party assigned by it.

- Concerning special orders, products manufactured according to the Customer's specifications and materials provided by the customer for inclusion in the product-manufacturing process, including fabric and upholstery supplied by the Customer are not covered by the warranty.
- Changes in colour, grain and texture due to: the passing of time, exposure to natural light, different batches and/or the natural origin of certain materials, such as wood, leather or natural bres, or, in the event, the artisan origin of certain parts involved in the production process.
- Colour differences of less than Delta-E 1 (in the case of plain colours) compared to the colour chart between different batches in a single delivery.
- Slight variations in the physical appearance of the order compared with the visual representations or descriptions provided by catalogues, samples and display parts, particularly variations in the colour, texture and grain of wood, and in fabrics.
- Typical variations in leather, such as cracks, insect bites or creasing, and variations in the colour or formation of creases due to the elasticity of the leather.
- Marks (from fingers), dirt and shine on dark and/or matt finishes.
- Marks or darker areas caused by failure to suitably protect the contact surface.

Warranty Conditions

It is the Customer's responsibility to check the received product before and during unloading, and to:

- Note any incident on the delivery note: suspicion of faulty packaging and/or product, wrong number of packages, and in this event:
- Take photographs of the load/packaging/product and make a complaint urgently, providing all relevant information, by email to the email address on the order confirmation request sent to the Customer.

If the Customer detects a non-conformity, then it must proceed to report the fact by email to info@brdr-kruger.dk, including/ attaching:

1. Description of the defect.
2. Photos of the defect, in general and in detail.
3. Clear identification of the product (order number): legible photo of the label, copy of the delivery note, copy of the invoice.

Any claim made which fails to provide the information described will not be accepted by Brdr. Krüger.

In the event of incidents detected during assembly, the Customer must proceed to report the fact, as indicated, within a maximum period of 72 hours. Any claim made after this period will not be accepted by Brdr. Krüger.

The subsequent care instructions are recommendations only. For general surfaces, we recommend using a damp cloth and we recommend that you always use environmentally friendly cleaning products and care for your furniture regularly and frequently. Before using any cleaning product, you should test it on an inconspicuous spot. Please follow the cleaning product manufacturer's instructions.

Fabrics:

To care for fabrics, simply Hoover dust and lint regularly. Stain removal: Fresh stains can usually be removed quickly by wiping immediately with an absorbent, lint-free sponge or cloth. Start from the outer edge of the stain and work towards the centre to avoid creating a halo effect. We recommend using normal household distilled water to prevent limescale residue from building up on dark fabrics after drying. Treatment of persevering stains: Brush dry stains lightly with a soft brush (such as a clothes brush). Depending on the type of stain, the use of solvents may be necessary. In such cases, it is essential to consult a professional. Under no circumstances should cover fabric surfaces be rubbed vigorously. Please be sure to consult a specialist before using any solvent-based cleaning product.

Leather:

Leather furniture should not be exposed to direct sunlight and should be kept some distance away from sources of heat; otherwise, the leather can dry out and become rigid. To ensure that leather remains soft and supple and that its natural protective film against water and grease remains intact, we recommend that you treat your furniture once a year with a mild cleaner. Stain removal: Superficial dirt can be removed with a damp cloth as long as care is taken not to wet the leather and not to apply direct pressure. You should also avoid rubbing too hard. For cleaning, we recommend using a special leather cleaner in foam or liquid form. Small dirt stains or pen stains are best removed with a colourless pencil eraser. To prevent the leather from drying out, you should subsequently always apply a designated care product from a specialist retailer. Liquids should be dabbed away immediately with a cloth and, if necessary, wiped off with a little water. Please do not use any aggressive agents such as stain removers, turpentine, shoe polish, etc.

Metal:

Stain removal: For quick removal of contaminants on polished high-shine, matte chrome and aluminium surfaces, apply a glass cleaner with a clean, soft cloth and subsequently wipe the surface dry with a soft cloth. For

stainless steel, we recommend using a special stainless steel care spray, steel cleaner or detergent. Powder-coated surfaces should be cleaned with aqueous solutions made from pH-neutral (pH 5-8) detergents or cleaning products and soft, non-abrasive cloths, rags or industrial cotton batting. Always clean metal surfaces gently and without scrubbing so that the surface is not scratched. Never use cleaners containing granular substances, acetic acid or citric acid.

Wood:

Wood is long-lasting, especially when its qualities are properly exploited. Furniture made of wood reacts to its environment; exposure to light, for example, alters its colour. And it is able to adapt its own moisture content levels to that of its environment. In the case of excessive fluctuations in temperature and humidity, however, it reacts by cracking and warping. Brdr. Krüger treats its solid wood tabletops with oil and other treatments to highlight and protect the properties of the natural material. To avoid stains and other damage, liquids should be wiped away immediately. Brdr. Krüger seals its veneers with a high-quality finish. Because of this, a soft, slightly damp cloth – with a mild detergent in the case of stubborn dirt – is sufficient for cleaning solid wood and veneer surfaces. Wet surfaces should be dried immediately with a cloth. Do not use any harsh cleaning agents or care products containing silicone or abrasives. If possible, avoid rubbing the surface while cleaning it, as this will make matte finishes shiny and charge the varnish with static electricity which will attract more dust. We do not recommend using furniture polish or wax, as they contain unsuitable solvents and/or colour additives and leave a coating that is very difficult to remove.

Laminate And Glass Table Tops:

Clean with a soft cloth tightly wrung out in clean water. For dirty surfaces, use a mild soap flake solution or a mild universal cleaning agent. Then polish with a soft, dry cloth.

<https://www.brdr-kruger.com/maintenance>

Check the goods when you receive it.

Our shipments are sometimes damaged during transport, even though we pack carefully. It is not always possible to check on the packaging whether the product is damaged in shipping.

To cover the transport damage, do the following:

1. While the driver is present: Unpack the items from the packaging and check them for damage before signing the shipment note.

If all goods are damaged, refuse receipt. If only some items are damaged or are slightly damaged, please write on the shipping note that the items are received subject to shipping damage.

2. The driver does not have time to wait: Please note on the consignment note that the goods are received subject to transport damage. Then check the goods and notify us immediately if the shipment is damaged.

It is very important that you immediately check the shipment for damage. You risk losing the right to cover the carrier's damages if not stated on the shipping note.

Brdr. Krüger is not responsible for damages caused during transport. On the other hand, we may hold the carrier responsible if you comply with your obligation to investigate the shipment upon receipt and respond promptly in the event that the shipment is damaged.

It is a good idea to take photos of the damage and of the consignment note, or to have documentation.

Contact Brdr. Krüger at info@brdr-kruger.dk or
Tel: +45 39 56 15 55

Contact Information



CUSTOMER SERVICE & SALES

Info@brdr-kruger.dk
T: +45 39 56 15 55
M: +45 20 93 09 59

PRESS

JONAS KRÜGER
Jonas@brdr-kruger.dk
T: +45 39 56 15 55
M: +45 30 25 61 31

PRODUCTION HQ

BRDR. KRÜGER
Walgerholm 20
DK-3500

SHOWROOM

Bredgade 28 A
DK-1260

FLAGSHIP STORE

Bredgade 28 B
DK-1260

WEBSITE:

www.brdr-kruger.com